

R18CS-0 18V Circurlar Saw XXX

5133002338 - R18CS-0 18V - 4000444425





4000444425

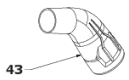
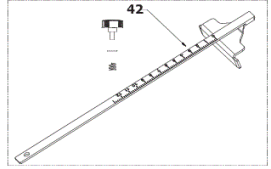
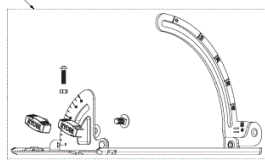
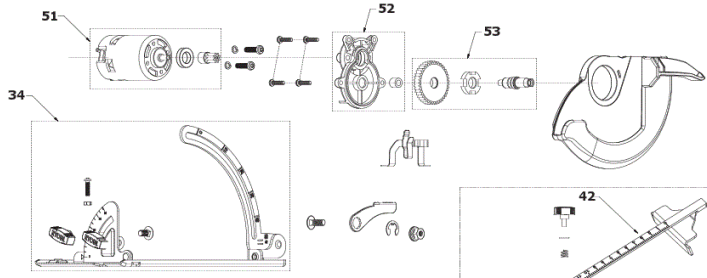
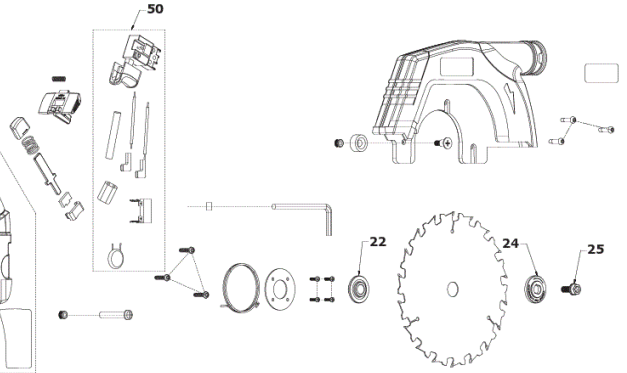
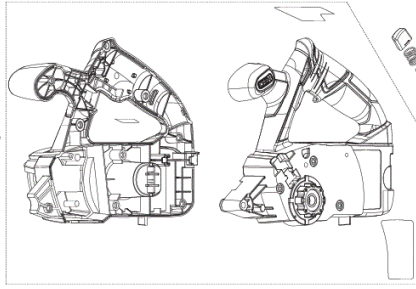
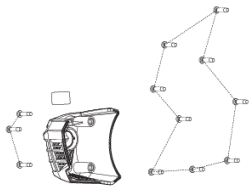

Position	Quantity	Description	Part number	EAN
022	1	FLANGE	5131041789	4058546250034
024	1	CLAMPING FLANGE	5131041790	4058546250041
025	1	SCREW	5131030406	4058546124618
034	1	ABSOLUTE UNIT	5131041243	4058546065072
042	1	EDGE GUIDE	5131001023	4058546338626
043	1	CONNECTOR	5131041216	4058546064808
050	1	SWITCH ASSEMBLY	5131033403	4002395161973
051	1	MOTOR ASSEMBLY	5131033404	4002395161980
052	1	GEAR BOX HOUSING	5131033405	4002395161997
053	1	PINION	5131033406	4002395162604
	1	CSB165A1 165mm 40T Circ Saw blade EN	5132002774	4892210135599